



**Replacement Part | Specification**

Model (SKU)

**A230-241-Finish**

ADA 24" Straight Grab Bar  
(Contemporary)

**Applicable Features & Installation Types**

- Stainless steel construction
- Mounts with TileWare anchoring systems only
- BUY US ONCE FOR LIFE



**Codes / Standards Compliance**

Meets or exceeds the following at date of manufacture:

- All applicable US Federal and State material regulations
- ASTM F446 Standards and conforms to ADA guidelines

**Color (Metal Finish)**

- PC Polished Chrome
- BN Brushed Nickel
- ORB Oil Rub Bronze
- BLK Matte Black

**For Tile**

**T**

Tile Thickness Range  
5/32" – 1/2" (4mm – 13mm)

- Victoria™ Series
  - Grab Bars
    - T200-011**

**For Trim Only**

**TX**

Tile Thickness Range  
5/32" – 1/2" (4mm – 13mm)

- Victoria™ Series
  - Grab Bars
    - TX200-011**

**For Drywall**

**G**

Gypsum Wallboard Surfaces

- Victoria™ Series
  - Grab Bars
    - G200-011**



**Replacement Part | Specification**

Model (SKU)

**A230-241-Finish**

ADA 24" Straight Grab Bar  
(Contemporary)

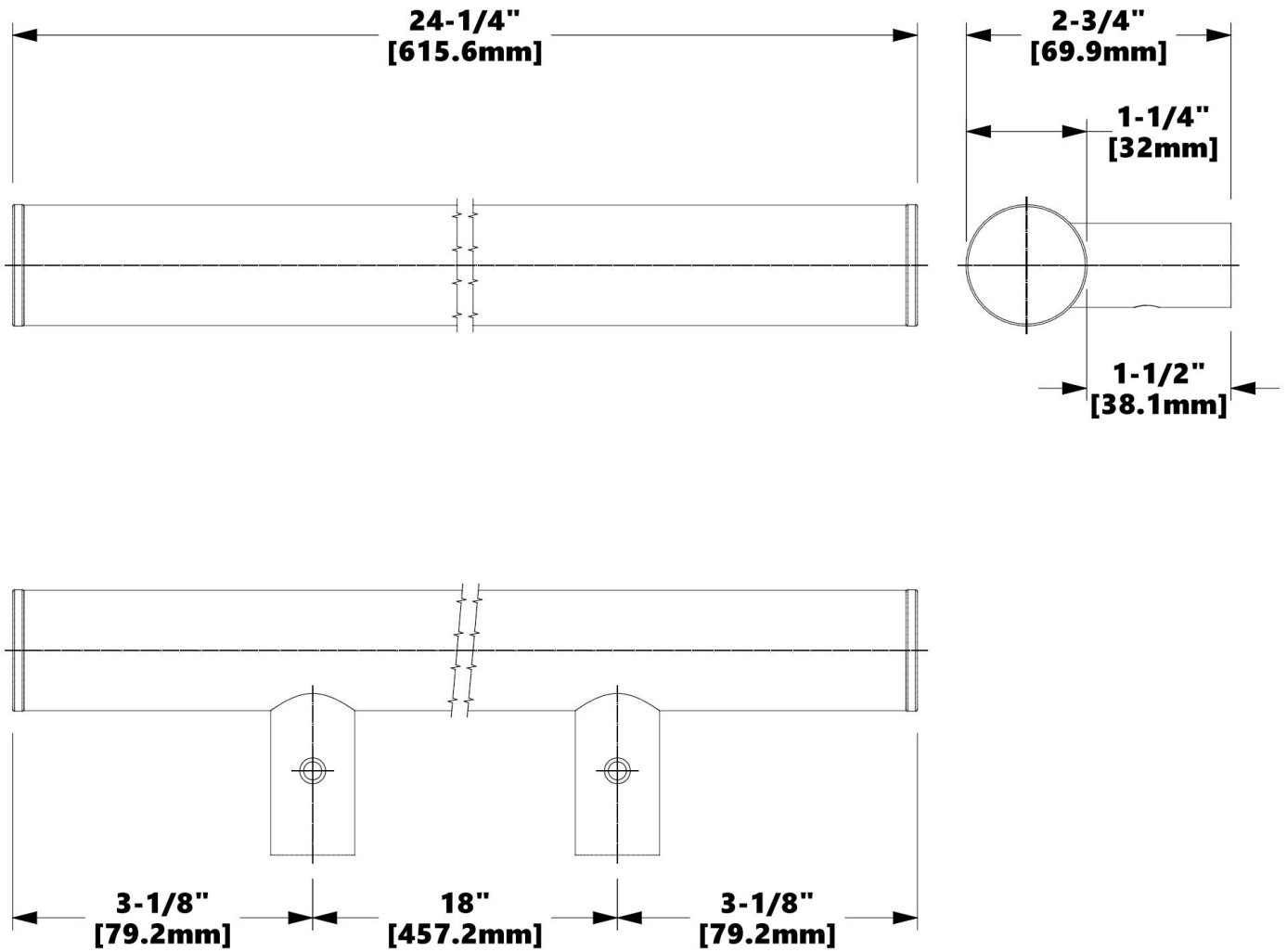

Meets or exceeds  
ASTM F446 standards and  
conforms to ADA guidelines

**Product Dimensions** (units are in both inches and mm)

**Weight**

1.515 lb / 0.687 kg

432A